



in.xm™



Mid-range spa pack platform

TechBook

Featuring in.therm™ remote heater



So advanced!
It's like walking on water!

Aeware  by gecko®



Table of contents

introduction	3	spa pack error codes	
warnings	4	- SP error codes	20
features	5	- SP corrective actions	22
overview		heater error codes	
- in.xm™ overview	7	- RH error codes	26
- in.xm™ dimensions	8	- RH corrective actions	28
installation		accessories error codes	
- floor installation	9	- high voltage devices/accessories	32
- wall installation	10	- accessories corrective actions	34
connections		testing the ozonator.....	38
- electrical wiring	11	gfcı trips	39
- in.link™ connectors	13	in.k600™ keypad function description	40
powering up the unit	14	viewing current management data	
in.xm™ configuration		- tech menu	41
- setting the learning mode	15	in.therm™	
- setting breaker settings.....	15	overview	47
troubleshooting section		installation	48
interface	18	connecting in.therm™ to in.xm™	49
		specifications	50



Aeware 3
by gecko ®



in.xm™

Most rugged spa pack platform ever developed for spa and hot tub manufacturers.

Our new and innovative in.xm™ spa pack platform includes all the features and functions you need in a stunning new power box design that sets new standards with its superb combination of looks and functionality.

With its waterproof enclosure & breakthrough connectors, in.xm™ boasts the highest water resistance ever designed in a pack, just one of a long list of innovative features that make in.xm™ the safest and most reliable spa pack platform ever offered to the industry.

Versatile and heater-“less”, in.xm™ can be wall-mounted or installed on its mounting base and comes with a perfect companion, our new in.therm™ intelligent remote water heating system.

Form truly follows function in this system packed with innovative built-in features and ground-breaking flexibility.

**WARNINGS:**

Before installing or connecting the unit, please read the following.

- * FOR UNITS FOR USE IN OTHER THAN SINGLE-FAMILY DWELLINGS, A CLEARLY LABELED EMERGENCY SWITCH SHALL BE PROVIDED AS PART OF THE INSTALLATION. THE SWITCH SHALL BE READILY ACCESSIBLE TO THE OCCUPANTS AND SHALL BE INSTALLED AT LEAST 5 FEET (1.52 M) AWAY, ADJACENT TO, AND WITHIN SIGHT OF THE UNIT.
- * ANY DAMAGED CABLE MUST BE IMMEDIATELY REPLACED.
- * TURN POWER OFF BEFORE SERVICING OR MODIFYING ANY CABLE CONNECTIONS IN THIS UNIT.
- * TO PREVENT ELECTRIC SHOCK HAZARD AND/OR WATER DAMAGE TO THIS CONTROL, ALL UNUSED RECEPTACLES MUST HAVE A DUMMY PLUG.
- * THIS CONTROLLER MUST NOT BE INSTALLED IN PROXIMITY OF HIGHLY FLAMMABLE MATERIALS.



In.xm™ boast a long list of technical features. Each of them stands on its own merits and contributes to bring to spa and hot tub manufacturers the most advanced solutions available to them:



In.put™
new input terminal bloc

In.put™ was designed to ease wire insertion (up to # 4 AWG) and connections. Tighter input connection reduces heat generated for increased component lifetime.



In.seal™
watertight protection

In.seal™ provides extra level of protection against water infiltration. Connectors and power box are designed to be watertight and no water can be in direct contact with electrical components.



In.axess™
board access prevention

Electronic components are placed into separate and inaccessible compartments. Only serviceable parts are made accessible to service technicians.



In.kin™
kinetic heat monitoring

First ever UL approved kinetic heating protection manages water temp. increase generated by pump heat dissipation. Hardware protection shuts all accessories off if it senses water overheat.



In.flo™
dry-fire protect

A new heater safety system located in the in.therm™ power box - an all-electronic dry-fire protection.



In.t.cip™
water temp. algorithm

In.t.cip™ is an intelligent water temp. refresh algorithm that calculates optimal time to start pumps and get water temp. readings. In.t.cip™ continuously readjusts heater start time.



In.link™
ingenious plugs and connectors

In.link™ cables are very cool output and input plugs and connectors that come with colored and tagged polarizers. Totally waterproof, they are designed to be easily configured and to ensure that all cables of equipment used to make a spa or an hot tub work properly are well connected at their intended connection port, eliminating any risk of mis-wiring.

In.link™ output connectors:

Color	Output	Typical Device
Red	Rh	Remote Heater
Orange	P1	Pump 1
Purple	P2	Pump 2
Green	P3	Pump 3
Red	A1	General Purpose
Blue	BL	Blower
Green	CP	Circulation Pump
Gray	O3	Ozone
Orange	Di	Audio/Video device



In.scan™
system auto-diagnostic

Auto-diagnostic module with multiple detection levels, in.scan™ continuously reads current at in.put™ to monitor breaker status. It also identifies corrective actions by displaying error codes on the box display.

North American model



CE model





In.xm™ overview

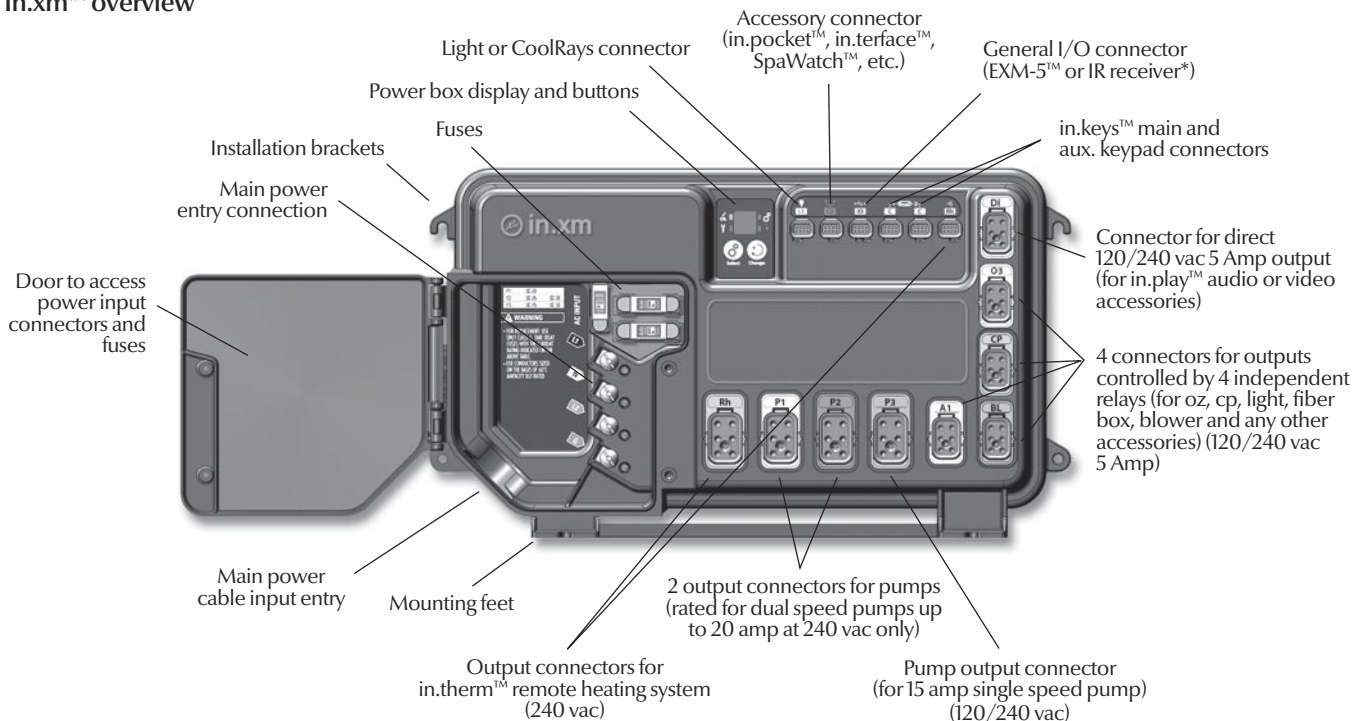

● Attention: output connector configuration is not the same in European models.

* IR receiver available on every LV connection except LI and RH



In.xm™ dimensions:

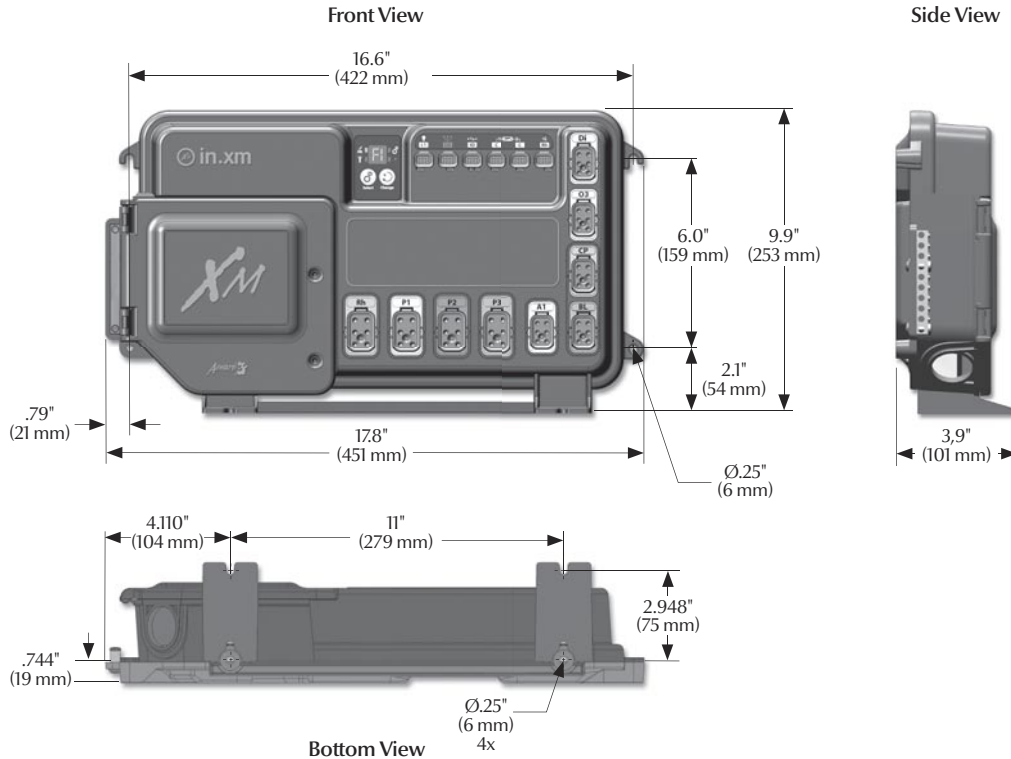



Floor installation procedure

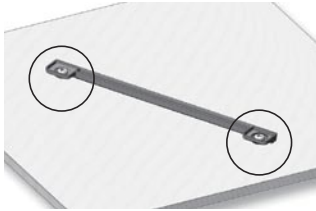

The following material is recommended:

4- # 10 screws of appropriate length with round, truss or pan head.

4- washers 1/2 OD x 1/16" thickness.

Select the most appropriate location on the floor for spa pack and firmly attach guide plate to wooden base with (2) screws backed by (2) washers.

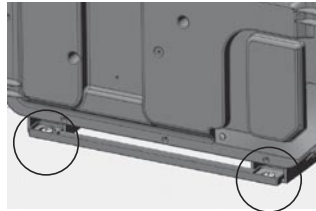

Slide back side of the unit's foot into the guide plate. It should easily slide into place.

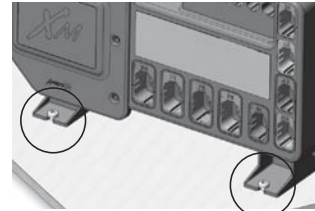

Now firmly attach unit to wooden base by using the remaining (2) screws backed by (2) washers to fix the front of the foot.

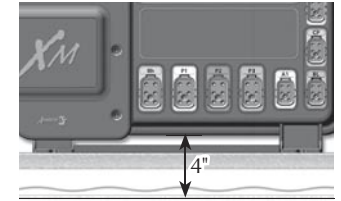

Note: The spa pack must be installed at least 4 inches above potential flood level. If floor is on ground level, pack should be raised at least 4 inches.

Warning:

Beware the application of some products commonly used against corrosion (such as WD-40 family products) could damage the power box, due to a negative chemical reaction between some industrial oils and its plastic enclosure. Any other materials which may come in contact with the enclosure must be carefully evaluated under end use conditions for compatibility.

Important!

Please note that **countersunk** screws should **not** be used as they can damage the power box support.



Wall installation procedure

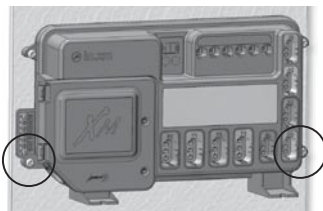

The following material is recommended:

- 4- # 10 screws of appropriate length with round, truss or pan head.
- 4- washers 1/2 OD x 1/16" thickness.

Select the most appropriate location on wall for spa pack and firmly attach, one at the time, upper mounting holes on each side of the spa pack to wall with (2) screws backed by (2) washers.

Firmly attach lower mounting holes on each side of the pack with the (2) remaining screws and (2) washers.

Note: Make sure these (2) screws and (2) washers are installed. They will make the pack stable when input, outputs and accessories connectors will be manually inserted in their ports.



Electrical wiring

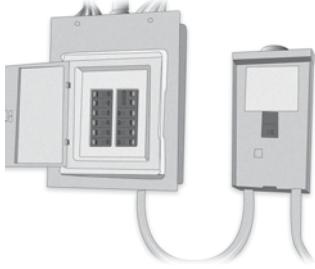

Main electrical box GFCI panel

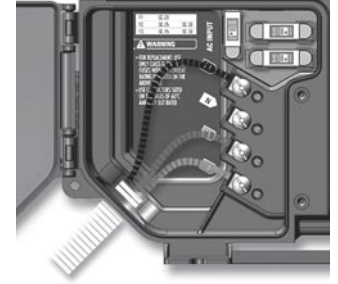
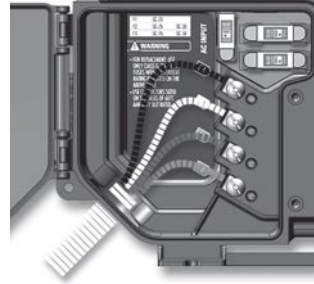
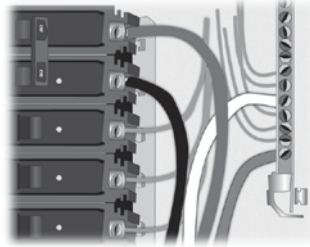

Warning!

"For units for use in other than single-family dwellings, a clearly labeled emergency switch shall be provided as part of the installation. The switch shall be readily accessible to the occupants and shall be installed at least 5 feet (1.52 m) away, adjacent to, and within sight of the unit".

For 240 VAC (4 wires)

Correct wiring of the electrical service box, GFCI, and pack terminal block is essential. Call an electrician if necessary.

For 240 VAC (*3 wires)

*If connected to a 3 wire system (without neutral), all 120 VAC components will not work.



Electrical wiring

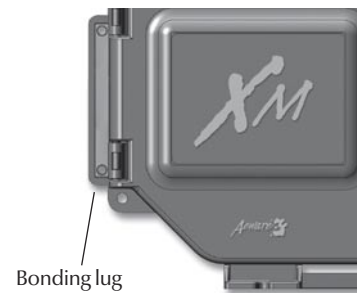
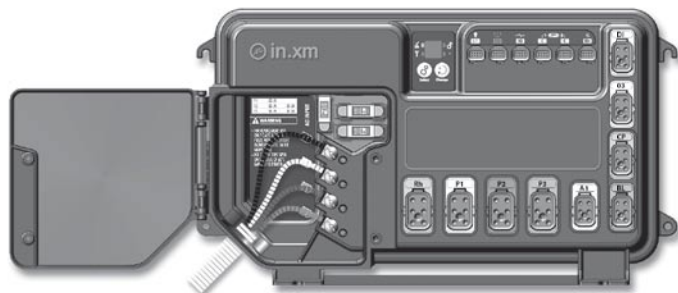

Bonding lug

Warning!

This product must always be connected to a circuit protected by a ground fault interrupter.

Proper wiring of the electrical service box, GFCI and in.xm™ terminal block is essential!

Check your electrical code for local regulations. Only copper wire should be used, never aluminum.

To install the wiring for the in.xm™ spa control, you'll need a Phillips screwdriver, a 9/16" nut driver or a flat screwdriver.

Loosen the 2 screws of the spa pack door and open it. Remove 8" of cable insulation. Strip away 1" of each wire insulation. Pull the cable through the cut-out of the box and secure it with a strain relief (1" NPT trade size)*. Make sure that only the uncut sheathing is clamped at this opening. Push the color-

coded wires into the terminals as indicated on the sticker and use the 9/16" wrench or flat screwdriver to tighten the bolts on the terminals.

After making sure wire connections are secure, push them back into the box and close the door. Tighten the 2 screws of the spa pack door.

Connect the bonding conductor to the bonding lug on the left side of the in.xm™ spa pack (a grounded electrode conductor shall be used to connect the equipment grounding conductors).

*Note : It's recommended to use a waterproof strain relief, rated IPX5 or greater.

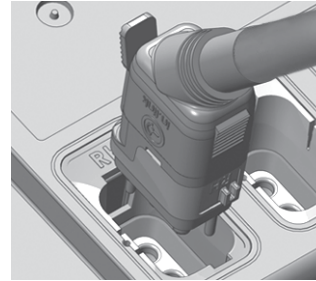
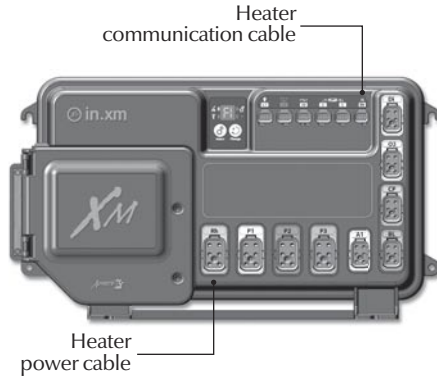

in.link™ connectors

In.xm™ features in.link™ connectors with colored and tagged polarizers. This new plug and connector technology has been specifically designed for easy and safe assembly. The tags are interchangeable depending on the output; the polarizers are designed to avoid misconnections.

In.link™ connectors are easily and conveniently accessible from the front of the pack offering a wide range of possible connection configurations. In.link™ connectors come in 3 sizes (HC, LC and low voltage) for all types of inputs and output devices.

They all include an integrated latch that keeps them safely in place and provides audible and tactile feedback when properly connected.

Finally, colored and tagged polarizers provide a definite advantage in reducing SKU numbers and inventory levels thus giving OEMs and dealers total flexibility to easily configure output devices.



Bonding lug

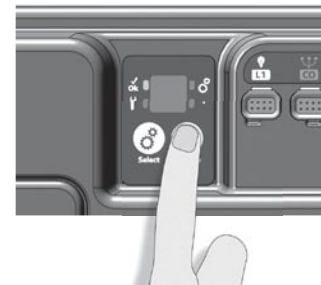
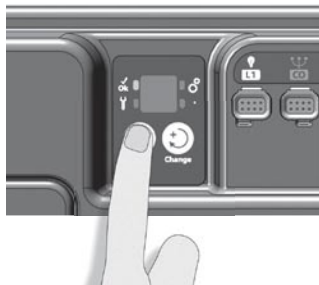

Make sure all accessories are linked to the bonding connector and connected to pack.

Make sure the spa pack door is closed.

Turn on the breaker.

Press **Select** button to change breaker setting.

The in.scan™ display will show the breaker setting menu.

It is important to specify the current rating of the GFCI used to insure safe and efficient current management (and no GFCI trippings).

Br values displayed by the system correspond to 0.8 of the maximum amperage capacity of the GFCI.

GFCI	Br
60 Amp	48 Amp
50 Amp	40 Amp
40 Amp	32 Amp
30 Amp	24 Amp

Use **Change** button to set the current breaker rating then press **Select** button.

All receptacles will match the corresponding female connection on the spa pack. No connectors should remain unplugged. Use blank plugs to fill unused connectors.

Note: Every OEM has its own preset configurations.



Description



Select

Select button is used to access the breaker setting menu (short press) as well as the low level programming menu (Press and hold for 5 seconds). Subsequent presses will save changes and display the next option available or exit automatically if it was the last one.



Change

Use Change button to change the parameters displayed.

Selecting Breaker (Br) settings



br

Press Select button once to activate the breaker setting menu. Once activated, the display shows "br" and, in succession, the maximum current rating of the breaker.



Press Change button to change setting.



Press Select to confirm. You will exit menu automatically (in.xm™ will also reset).



Note: this procedure has to be performed after every learning mode.

Setting the learning mode

The in.xm™ pack has the ability to verify and "learn" the current consumption of every output connected to it. If an output is replaced, a new learning must be done. Follow these simple steps:



LL

Press and hold Select button for 5 seconds to activate low level programming. Once activated, the display shows "LL" and, in succession, the current preset low level configuration selected.



Press Change button repeatedly to select the same preset low level configuration again.



Press Select to confirm. You will exit menu automatically. The in.xm™ will then reset. After resetting, the system starts a "learning sequence" in which each individual output is activated and its peak current displayed and saved.

Note: if unusual current readings e.g.: 4 to 6 amps are detected on the high speed of any pump, all pumps must be primed and the learning mode should be restarted.

Note: Every OEM has its own preset configurations.

in.xm



Mid-range spa pack platform

Troubleshooting section



So advanced!
It's like walking on water!

Aeware 
by gecko



In.xm™ troubleshooting advantage

In.xm™ unique troubleshooting features are called in.scan™ because in.xm™ has the capacity to scan itself and read the status of all exterior connected devices.

All error codes will be displayed on the keypad and on the in.xm™ display, making reading codes easier and more convenient.

Error codes

Error codes indicate a failure condition or a problem which needs to be corrected to ensure proper functioning of the system. Both the error code and device identification are alternatively displayed.

Note: Every OEM has its own preset configurations.

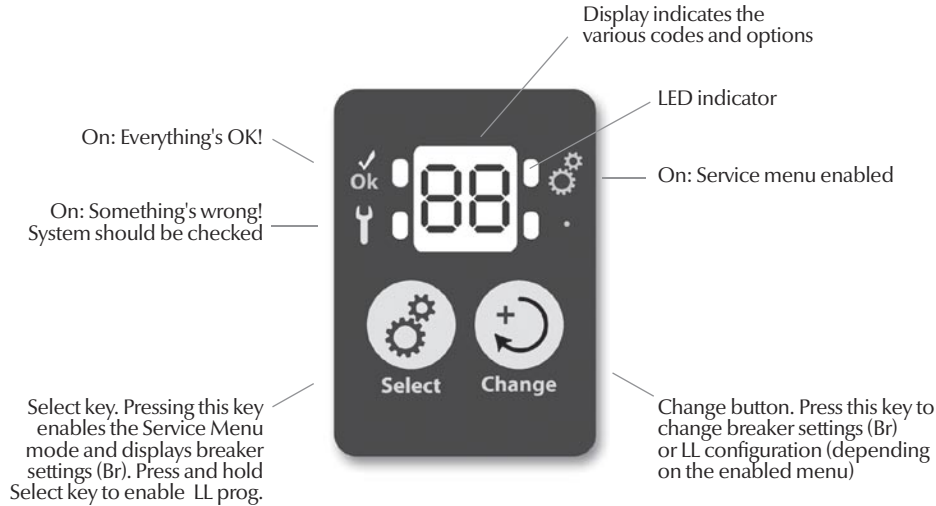

Error Codes

When displaying errors codes, both device ID and the related error code are displayed alternately. If there is more than one active error, the one with the highest priority is displayed. If problems are found on several devices, the priorities are as follows:

- in.xm™ (error "SP" for spa pack)
- in.therm™ (error "RH" for remote heater)
- high voltage devices accessories (P1, P2, P3...)

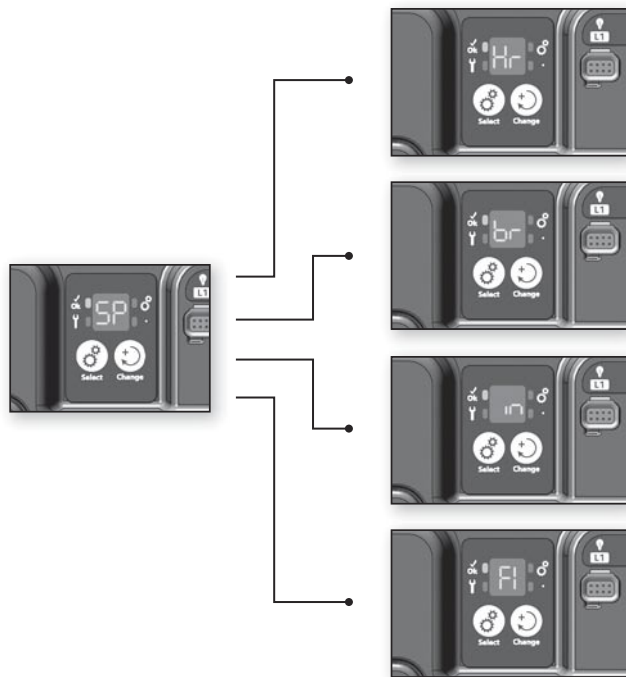

SP error codes

**SP - HR**

An internal hardware error has been detected in in.xm™.

SP - BR

The chosen input current rating is lower than the sum of current for all pumps.

SP - IN

The input voltage is too low.
Either there is a problem with the terminal connections or with the power lines.

SP - FI

In.xm™ Fuse FI is blown.
Fan, blower, circulation pump, fiber optic

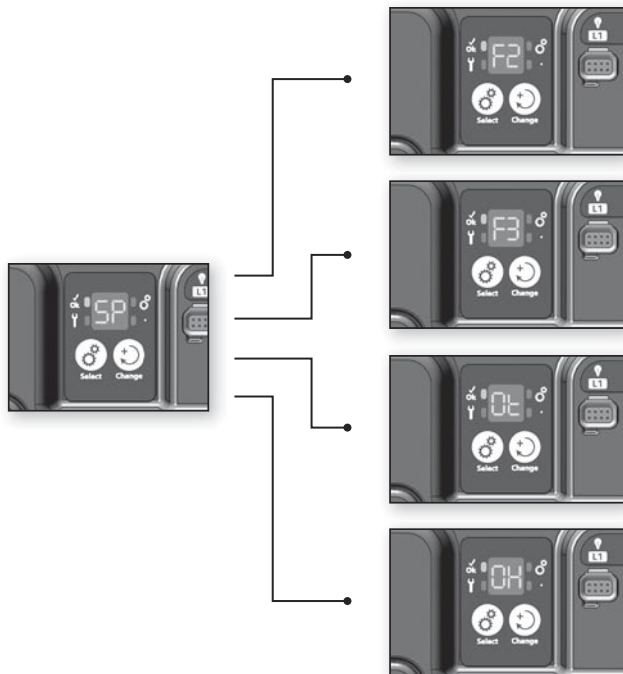
**SP - F2**

In.xm™ Fuse F2 is blown.

Pump 2, Pump 3 or blower that is more than 5 amp

SP - F3

In.xm™ Fuse F3 is blown.

Pump 1

SP - OT

Temperature inside the spa skirt is too high, causing the internal temperature in the in.xm™ to increase above normal limits (overheat condition).

SP - OH & blinking temperature higher than 112°F on the keypad display

The system detects spa water temperature exceeding 112°F (overheat condition).



SP - HR

Internal hardware error detected in in.xm™

- Restart the spa pack and start & stop all pumps and blower.
- If error reappears, replace in.xm™ spa pack.

SP - BR

Incorrect input current configuration setting

- Increase in.xm™ current rating and breaker setting.
- Increase breaker size and manufacturer's cable gauge or reduce pump size.

SP-Br is not considered an error code, therefore it doesn't trigger the service icon to appear on display. Although SP-Br should be viewed more as a warning, it won't allow the heater or any other accessory to come on if the amperage available is not adequate for the requirements.



SP - IN Input voltage issue

- Check input terminal connections to make sure they are correctly wired & tighten (see connection section)
- Have a certified electrician verify the quality of the power lines. You should have 240v between L1 & L2 and 120v between each line and neutral.

SP - FI In.xm™ Fuse FI is blown

- Replace the blown fuse FI with an identically rated replacement (SC-20, SC-25, etc.)
- If new fuse blows, disconnect fan, blower, circulation pump & fiber optic.
- Replace fuse and reconnect all components, one at a time, until fuse blows.
- Replace component that caused fuse to blow.



SP - F2

In.xm™ Fuse F2 is blown

- Replace the blown fuse F2 with an identically rated replacement (SC-20, SC-25, etc.)
- If new fuse blows, disconnect pump 2, pump 3 or blower.
- Replace fuse and reconnect all components, one at a time, until fuse blows.
- Replace component that caused fuse to blow.

SP - F3

In.xm™ fuse F3 is blown

- Replace the blown fuse F3 with an identically rated replacement (SC-20, SC-25, etc.)
- If new fuse blows, Replace pump 1.



SP - OT

Internal hardware temp. is too high

- Remove spa skirt and let system cool down.
- A breaker reset may be required to clear error.



SP - OH & blinking water temp. on the keypad display
water temperature exceeding 112°F is detected

- Remove spa cover and let spa cool down.
- Add cold water and lower filter cycle.
- If the temperature cools down within normal limits the error will reset itself.
- If error persists, measure the temperature with a DIGITAL thermometer and compare its reading with temp. on the display. If temp. reading is different, replace in.therm™.
- If problem persists replace pack.



RH error codes

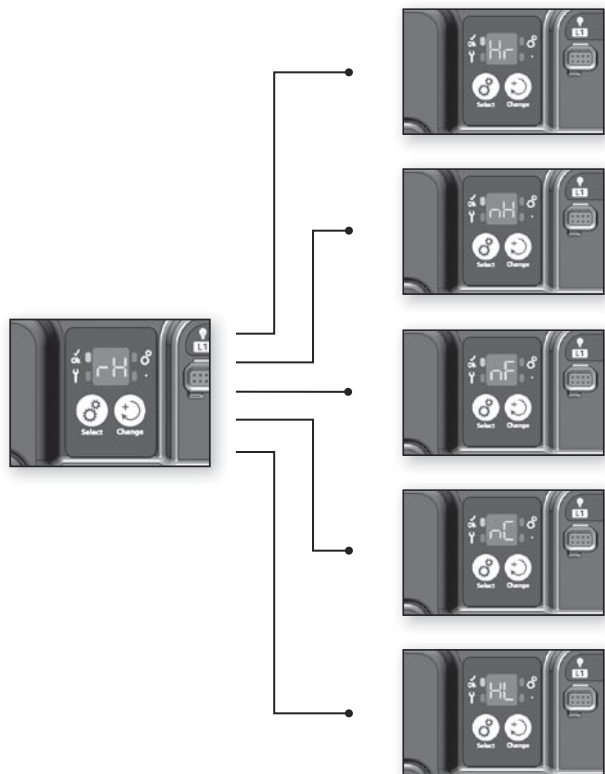

RH - HR

A hardware error was detected in in.therm™ (related to the electronic circuit only).

RH - NH

This error occurs if in.therm™ is trying to heat water but does not detect any increase in temperature.

RH - NF

This code is displayed when a “no flow” condition is detected by in.therm™.

RH - NC

Communication problem exists between in.xm™ and in.therm™.

RH - HL

High Limit hardware circuit tripped.



RH error codes

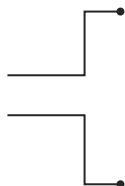

RH - PR

The system detects a problem with the regulation probe.
The system is constantly verifying if temperature probe readings are within normal limits.

RH - ID

The system detects a no match between the in.xm™ model and the in.therm™ model.



RH - HR

Internal hardware error detected in in.therm™

- Reset main breaker; make sure the heater restarts by changing set point and turning every output On and Off (Pumps).
- If problem isn't corrected, replace in.therm™.

RH - NH

A "no heat" issue is detected

- Verify if in.therm™ is properly connected. (You should hear a click!)
- Reset main breaker.
- Measure voltage directly on the Di connector (see illustration).
You should read:

240VAC at Di connector:
Pin 1 & Pin 2

120VAC at Di connector:
Pin 5 & Pin 6

120VAC at Di connector:
Pin 5 & Pin 2

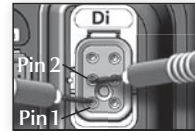

or

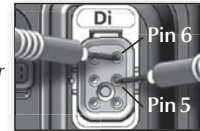

or

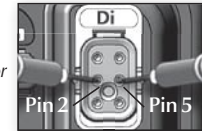

Note: 240VAC at Di connector will be the only reading possible if the installation doesn't have the neutral wire (3 wire 240VAC installation).

- If you don't get proper voltage readings, reset the main breaker.
- If you get an appropriate voltage reading, replace in.therm™.



RH - NF "No flow" condition detected

- Make sure water valves are open and that water level is high enough.
- Check and clean filters.
- Make sure there are no air locks (or that no object obstructs the passage of water in the in.therm™ channel). Pumps may make strange noises and error messages such as "PI ER" could appear.

Follow air lock procedure to clear them.

- Make sure that the pump associated to the heater (Pump #1) is running by pressing PI key.

If "PI ER" appears on display, go to Pump 1 error section and follow procedure.



RH - HL High limit hardware circuit tripped.

There are 2 possible causes:

- The heater was previously stored in a very hot location prior to installation and there is no water yet in its tube to cool it down.
 - Use a hose to cool down the interior of the tube.
- External ambient temp. is high enough to heat the water, even though the pumps remain off.
 - Add cold water in spa and let heater cool down.
 - Reset spa pack using current breaker.



RH - NC

Communication problem between in.xm™ and in.therm™

- Make sure remote heater cables are connected properly and that none of the cable connector pins are bent.

If problem persists, either the in.xm™ or the in.therm™ may need to be replaced (both parts must be returned since either part could be defective).

RH - PR

A problem with the regulation probe is detected

- This error message clears itself when the condition that triggered the event is no longer present.
 - Reset the breaker.
- If problem persists, replace the in.therm™.

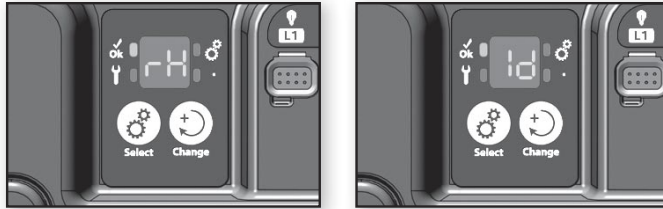

RH - ID

Incompatibility between the in.xm™ and in.therm™ models

The North American version of the in.xm™ pack can only be connected with the North American version of the in.therm™ heater. The same applies to the European version of both devices.

- The RH-ID message indicates that the European version of the in.therm™ heater (in.therm™ CE) has been connected to the North-American version of the in.xm™ pack (in.xm™ UL) or vice versa.

To correct the situation:

- Swap the in.therm™ or the in.xm™ for the appropriate version.



High voltage devices/accessories (P1, P2, P3..)

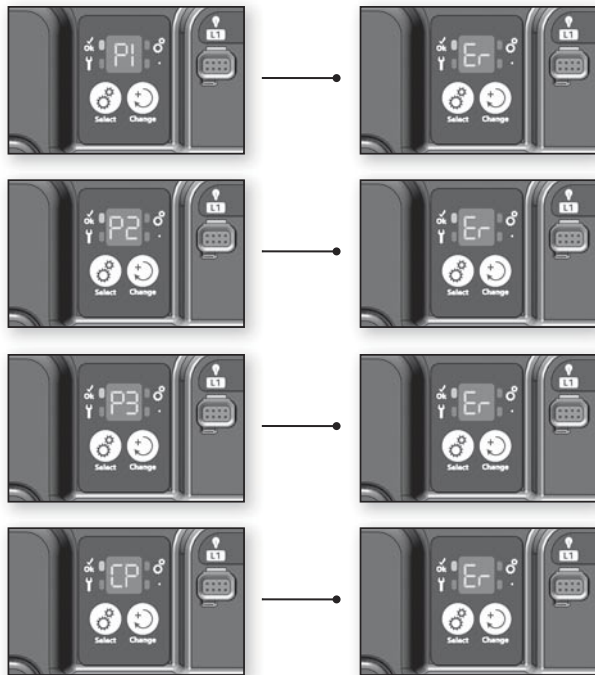

P1 - ER

System hasn't detected any current change when turning Pump 1 on or off

P2 - ER

System hasn't detected any current change when turning Pump 2 on or off

P3 - ER / P4 - ER / P5 - ER

System hasn't detected any current change when turning Pump 3, Pump 4 or Pump 5 at on or off

CP - ER

System hasn't detected any current change when turning circ. pump on or off

**BL - ER**

System hasn't detected any current change when turning blower on or off

**FN - ER**

System hasn't detected any current change when turning fan on or off

**SC - ER**

System learning error



P1 - ER

Pump 1 not responding

- Make sure Pump 1 is connected properly (when connecting plug, you should hear it click).
- Manually change output status (on/off) of Pump 1 and cycle through all possible states (i.e. low, high, off).
- Reset spa pack by pressing Select key twice.
- If error does not clear, problem is most likely with Pump 1. It will need to be replaced.
- If Pump 1 is replaced, a new learning routine must be performed (see procedure page 15).

P2 - ER

Pump 2 not responding

- Make sure Pump 2 is connected properly.
- Manually change output status (on/off) of Pump 2 and cycle through all possible states (i.e. low and high speeds). Reset spa pack.
- If error does not clear, problem is probably with Pump 2. It will need to be replaced.
- If Pump 2 is replaced, a new learning routine must be performed (see procedure page 15).

- If a pump error is detected during a flow check, the pump will remain activated while performing this task, for this reason, a 9 min. delay might be required to clear error.
- If the spa is equipped with an in.k600™ menu driven, the learned current value can be verified (see viewing current management data section for more details). Furthermore, if the current value learned by the in.xm™ spa control is not appropriate, it can trigger false Pump-ER error codes.



P3 - ER / P4 - ER / P5 - ER Pump not responding

- Make sure the Pump is connected properly.
- Manually change output status (on/off) of the Pump.
- Reset spa pack.
- If error does not clear, problem is probably with the Pump. It will need to be replaced.
- If the Pump is replaced, a new learning routine must be performed (see procedure page 15).

CP - ER Circulation Pump not responding

- Make sure Circ. Pump is connected properly.
- Manually change output status by changing set point.
- Reset spa pack.
- If error does not clear, problem is probably with CP. It will need to be replaced.
- If the CP is replaced, a new learning routine must be performed (see page 15).

Note: If the spa is equipped with an in.k600™ menu driven, the learned current value can be verified (see "viewing current management data" section for more details). Furthermore, if the current value learned by the in.xm™ spa control is not appropriate, it can trigger false Pump-ER error codes.



BL - ER Blower not responding

- Make sure blower is connected properly.
- Manually change the output status (on/off) of blower.
- Reset spa pack.
- If error does not clear, problem is probably with blower, it will need to be replaced.
- If blower is replaced, a new learning routine must be performed (see procedure page 15).



FN - ER Fan not responding

- Make sure fan is properly connected.
- Manually change the output status (on/off) of fan.
- Reset spa pack.
- If error does not clear, problem is probably with the fan. It will need to be replaced.
- If the fan is replaced, a new learning routine must be performed (see procedure page 15).
- Replace ozonator par Fan.

Important:

- If the fan doesn't draw more than 400 ma, the FN-ER error will not be displayed even if the fan is defective.

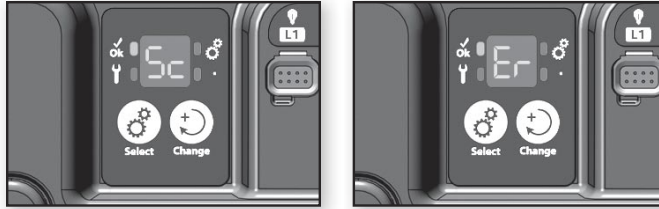

SC - ER

System learning error

Every time a low-level option is changed, system must “learn” currents associated to each output/load. During this learning process, the device connected to Di (direct output, no relay) must be disconnected IF IT DRAWS MORE THAN 0.4 AMP. If it isn't, system will report an SC error code.

- Disconnect load.
- Restart learning process by pressing Select key for 5 sec.
- Press Change key as many times as necessary to go through all low level programming settings (see low level programming section).
- When process is done, the accessory connected to Di can be reconnected.

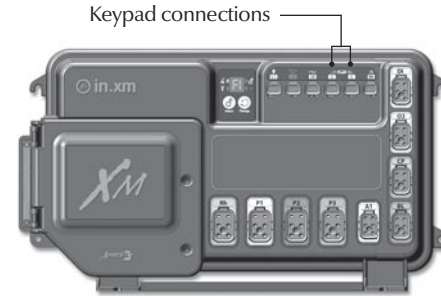

Keypad doesn't seem to work!

Note: Keypad connected to in.xm™ is only detected when main breaker is reset. Don't forget to reset breaker if you're changing keypad model (in.k400™ for in.k600™).

If a keypad doesn't seem to work:

- Verify keypad connections and try spare keypad.
- Replace keypad if problem is corrected.
- Replace in.xm™ if problem is not corrected.



Testing the ozonator

- Make sure ozonator is connected properly.
- Press and hold the change button until the message O3 flashes on display.
- Then, the system activates the pump associated to the ozonator (PI or CP) followed by the ozonator output.

Important: if the spa is equipped with the in.zone™ corona discharge ozonator, its LED indicator lights up to warn that the ozonator output has been activated.



Smart Winter Mode not a bug but a feature!

Our Smart Winter Mode protects your spa from water cold enough to freeze the pipes by automatically turning pumps on for one minute several times a day to prevent water from freezing in pipes.



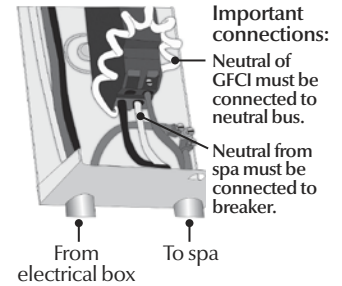
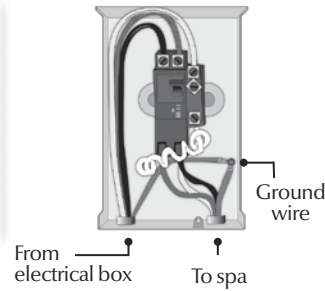
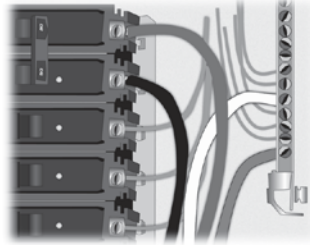
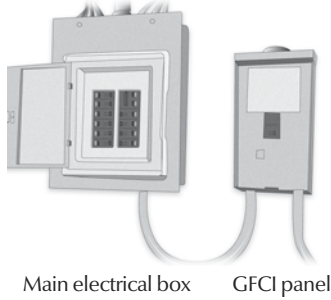

Warning!

There are different GFCI models used on the market. See manufacture's instructions that come with the GFCI for specific information. Note that all illustrations are examples only.

Verify if GFCI is properly connected.

If it's not, verify GFCI diagram and reconnect it.

Verify in.xm™ pack wiring (make sure that the neutral and the ground have not been inverted).

If the GFCI is properly connected but still tripping, unplug all outputs from the spa pack (pumps, heater, ozonator etc).

Reconnect one output at the time until the GFCI trips again.

Replace defective component.

Note: If the neutral of the GFCI is hooked up to the neutral bar, the in.xm™ spa control will only trip when the 120v outputs are fired (e.g.: the ozonator)



In.k600™ keypad menu driven interface

Multifunction Keys
1, 2, 3, 4

Each of these four keys helps you to select and/or execute the indicated function displayed on the screen in any given window. In this way, the task performed by a given multifunction key will vary depending on the menu or window.

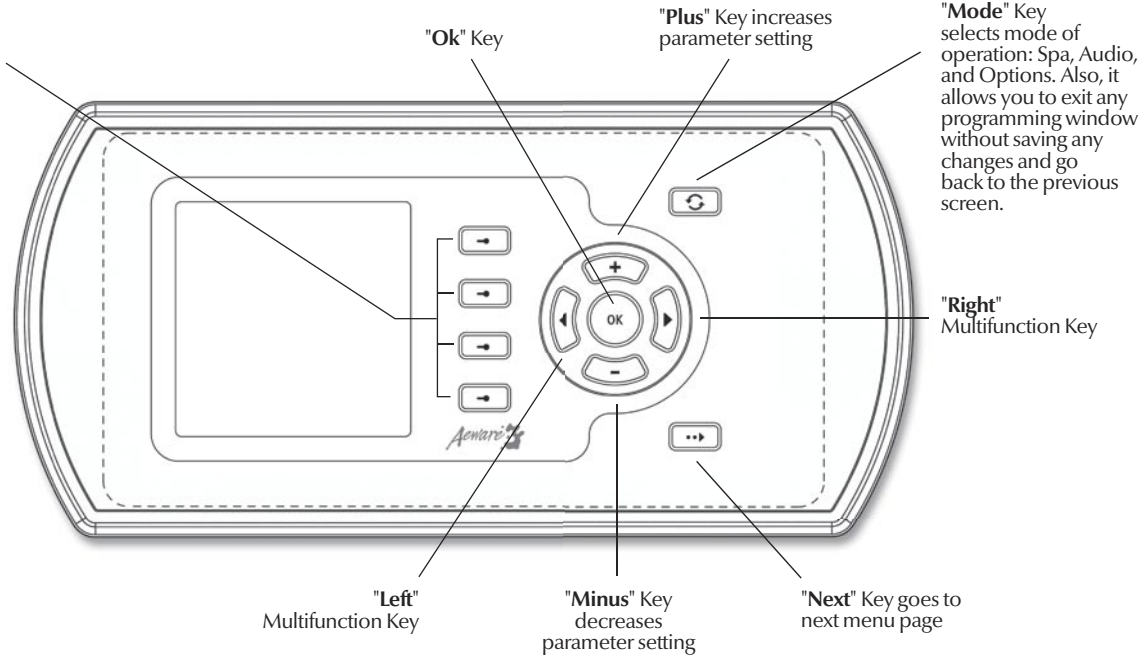

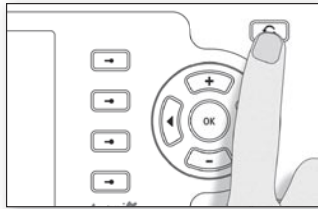

Tech menu

- Press **Mode** key  to display the mode selection window.

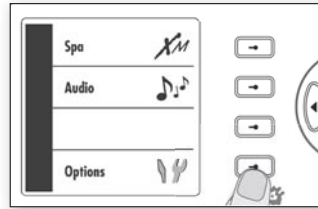

- Select **Options** menu

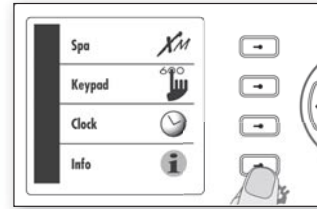

- Select **Info** sub-menu

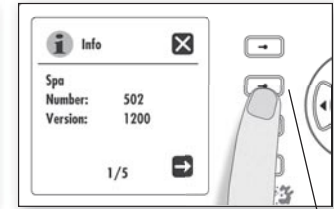

Multifunction key 2

- Press and hold **Multifunction Key 2** for 5 seconds to access **Tech menu** (see next page)

* Option available with in.k600™ menu driven keypad only.

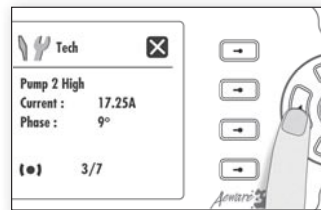
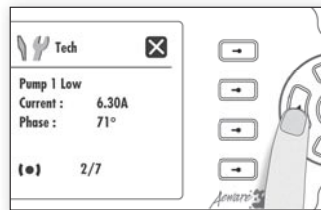
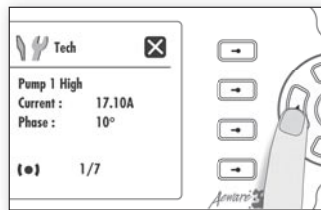
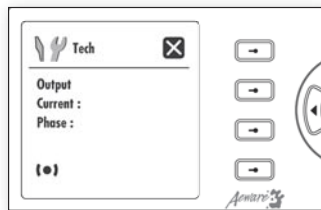

Tech menu

This menu allows you to view the speed (low or high in the case of the pumps), learned amperage data as well as the phase angle for each output.

Note:

If __ appears on any screen, it means that no significant current has been detected and "learned" by the system for that output.

Here Pump 1 high speed current and phase angle are displayed

- Use **Right** key to go to the next screen menu.

Here Pump 1 low speed current and phase angle are displayed

- Use **Right** key to go to the next screen menu.

Here Pump 2 high speed current and phase angle are displayed

- Use **Right** key to go to the next screen menu.



Note:

- Use **Right** key to go to next screen menu.
- Use **Left** key to go back to previous screen menu.
- Use **Ok** key or Select the **X** option to go back to the initial screen on the Tech menu.

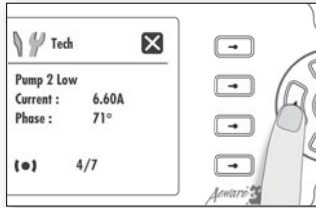

Tech menu

Here Pump 2 low speed current and phase angle are displayed

- Use **Right** key to go to the next screen menu.

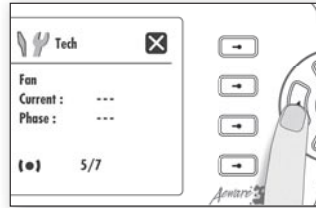

Here Fan current and phase angle are displayed

- Use **Right** key to go to the next screen menu.

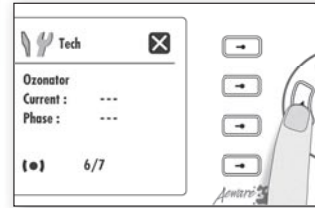

Here Ozonator current and phase angle are displayed

- Use **Right** key to go to the next screen menu.

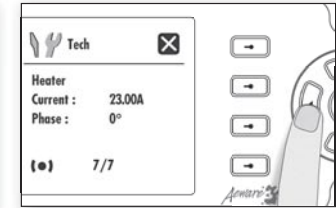

Here Heater current and phase angle (0°) are displayed

- Use **Right** key one last time to go back to keypad main menu.



in.therm

intelligent remote water heating systems



Designed to be totally
maintenance free!

Aeware
by gecko 





in.therm™

Intelligent remote water heating system designed to be totally maintenance free.

Separated from pack, in.therm™ is an intelligent 4kw remote heater that integrates electronics in its power box. It includes a built-in temperature probe and a new water flow detection feature that eliminates the need of a pressure switch. In.therm™ controls multiple power levels on a single element extending its lifetime by heating at high power only when needed. With no moving parts and no adjustments, in.therm™ is hassle free and defines new levels of reliability.

In.therm™ was designed to be easily and quickly installed. Threads and in.link™ cables make it easy to connect to pack system & spa pipes.



Totally sealed enclosure
(box & heat channel)

Nominal dimensions: 14,5" x 5" X 4"



Heater installation

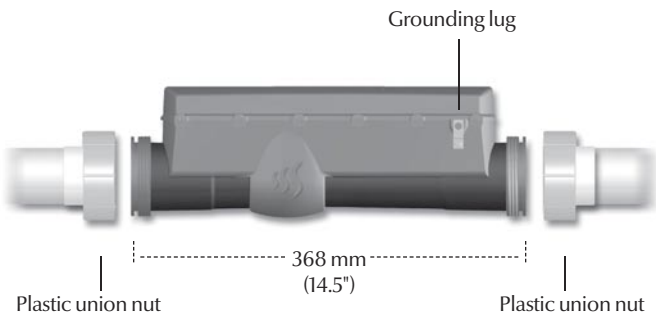

For an optimal connection to spa plumbing, please note that we recommend the following 2" compression fittings & nuts.



Waterway
#400-5570
www.waterwayplastics.com



Aquatemp
86-02335
www.aquatemp.com

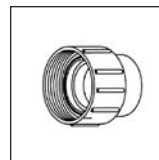

Aqua-Flo
52202000
www.aqua-flo.com

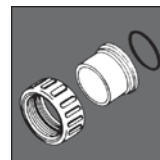

Magic Plastics
#0602-20
www.magicplastics.com



Install heater in the upright position as illustrated above.

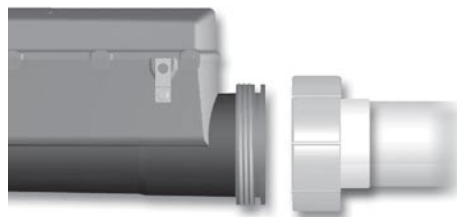

Slide the two 50 mm (2") plastic union nuts over the heater threaded ends and tighten the nuts.

Note: a minimum flow rate of 18 gpm is required.



Connecting in.therm™ to in.xm™

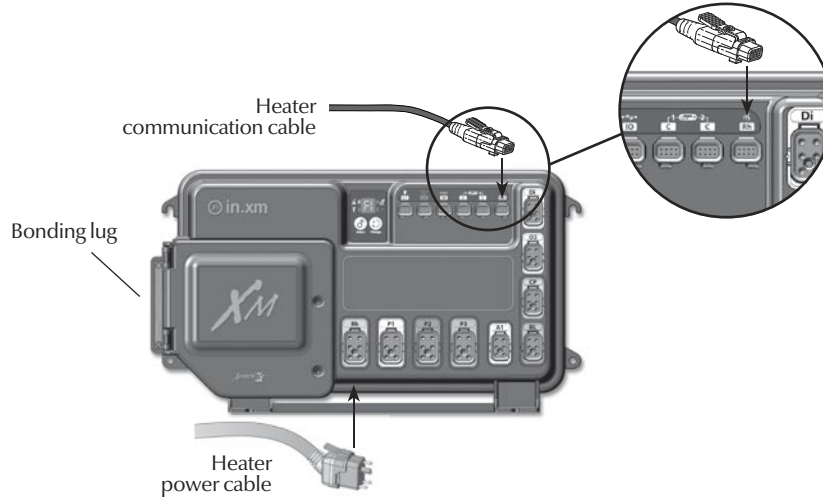

Connect the heater power cable to the in.link™ output connector indicated Rh on the spa pack.

Connect the heater communication cable to the low voltage connector indicated Rh on the spa pack.

Connect the bonding conductor to the bonding lug on the face of the in.therm™.

Important! CE and UL/CSA parts are not interchangeable!



In.xm™ electrical specifications:

Input rating: 120/240 VAC (2-phase required, with or without neutral) 48 A maximum, 60Hz.

Input operation specification: 240 VAC (-10% / +5%)

Output ratings:

Output	Voltage	Current	Device
Out 1	240 V	20FLA	Pump 1
Out 2	240 V	15 FLA	Pump 2
Out 3	120/240V	15 FLA	Pump 3 or large Blower
Out 4	120/240V	6 FLA	Aux 1
Out 5	120/240V	6 FLA	Blower
Out 6	120/240V	6 FLA	Circulation Pump (CP)
Out 7	120/240V	6 FLA	Ozone Generator
Out 8	120/240V	6 FLA	Audio/Video device

Important:

- 48 A absolute maximum, distributed on all outputs
- 25 A maximum total for all 120 VAC loads
- 20 A maximum total for OUT2 and OUT3 combined
- 11 A maximum total for OUT4 to OUT8 combined
- Maximum loads are determined by fusing restrictions and ambient temperature. In all output configurations, the total current output must never exceed input ratings.

L1	Light, 1 A / 10 VAC (-5%/+10%) @ 240 VAC / 60Hz
CO	Communications port *
C1	Top side controller *
C2	Top side controller **
IO	General purpose I/O port **

* C1 and CO: 125 mA max on 5 Volts.

** C2 and IO: 125 mA max on 5 Volts.

Important:

- All low voltage accessories use +5Vdc and/or on +12 Vdc.
- All low voltage accessories combined: 300 mA max, on +12 Vdc.



General specifications:

Environmental:

Operating temperature: 0°C (-32°F) to 50°C (122°F)

Storage temperature: -25°C (-13°F) to 85°C (185°F)

Humidity: up to 80% RH, non condensing

Mechanical:

Weight: 3.4 kg (7.6 lbs)

Dimensions (W x H x D):

Chassis: 185mm x 52mm x 275mm (7-1/4" x 2" x 10-3/4")

Standards:

UL 1563 Fifth Ed.

CSA No. 22.2 - 218.1-M89



In.therm™ supply ratings:

Voltage: 2-phase, 240VAC

Current: 17 A maximum (4 kW heater)

Frequency: 60 Hz

In.therm™ output ratings:

Heater element: 17A resistive (240 VAC only)

In.therm™ flow rates:

Minimum of 18 GPM is required

Advanced electronics! Water resistance!



Gecko Alliance

450 des Canetons, Quebec City (QC) G2E 5W6 Canada, 1.800.78.GECKO
9225 Stellar Court, Corona, CA 92883 USA, 951.667.2000

www.geckoalliance.com

9919-100606
Rev. 05/10

Aenware **3**
by gecko